



Trigno[®] Wireless Biofeedback System

Spring Contact Adapter

User's Guide

Copyright © 2023 by Delsys Incorporated

MAN-042-1-2

MP1274C



No part of this document may be reproduced, transmitted, transcribed, stored in a retrieval system, or translated into any language in any form by any means without the written permission of Delsys Inc.

Important Information	3
Intended Use	3
Contraindications	3
Technical Service and Support	3
Warnings and Precautions	4
Device Information.....	5
Windows PC Requirements	6
Android Device Requirements.....	6
Trigno System Overview	7
Trigno Avanti Spring Contact Adapter Features	7
Differential EMG Sensing	8
Inertial Measurement Unit	8
Dual Mode “BLE-Base” Communication	8
Wireless Communication	8
Data Synchronization	8
Rechargeable Battery.....	8
Sealed Enclosure.....	9
Internal Magnetic Switch	9
Sensor LED Feedback States	9
Getting Started with the Trigno Sensor	11
Configuring the Spring Contact Adapter	11
Using the Analog Outputs (if Equipped)	11
Placing the Spring Contact Adapter on the Skin	12
Using the Spring Contacts	12
Applying the Trigno Adhesive Skin Interfaces	13
Maintenance and Care	14
Trigno Sensors	14
Specifications	15
Physical Specifications	15
Electrical Specifications	15
EMG Measurement Data Modes.....	16
Inertial Measurement Data Modes	17
Orientation Measurement Data Modes	19

Important Information

Intended Use

The Trigno Avanti Spring Contact Adapters are components of the Trigno[®] Wireless Biofeedback System. This system is a battery-powered biofeedback device that enables researchers and clinicians to acquire EMG and related signals from subjects for biofeedback and research purposes. The System is intended for relaxation training and muscle reeducation. Interpretation of the EMG and supporting signals by a qualified individual is required.

Rx ONLY

Contraindications



DO NOT USE on Patients with implanted electronic devices of any kind, including cardiac pace-makers or similar assistive devices, electronic infusion pumps, and implanted stimulators.



DO NOT USE on irritated skin or open wounds.



DO NOT USE on Patients with allergies to Silver.



DO NOT USE in critical care applications.

Technical Service and Support

For information and assistance please visit our web site at:
www.delsys.com

Contact us at:

E-mail: support@delsys.com

Telephone: (508) 545 8200

Warnings and Precautions



Consult all accompanying documents for precautionary statements and other important information.



Consult accompanying user's guide for detailed instructions.



Keep the device dry. The ingress of liquids into the device may compromise the safety features of the device.



Handle with care.



Sensitive electronic device. Avoid static discharges. Do not operate or store near strong electrostatic, electromagnetic, magnetic or radioactive fields. Interference from external sources may decrease the signal-to-noise ratio or result in corrupted data.



Connect only to Delsys-approved devices.



Connecting a patient to high-frequency surgical equipment while using Delsys EMG systems may result in burns at the site of the EMG sensor contacts



Immediately discontinue device use if skin irritation or discomfort occurs.



Immediately discontinue device use if a change in the device's performance is noted. Contact Delsys technical support for assistance.



Delsys Inc. guarantees the safety, reliability, and performance of the equipment only if assembly, modifications and repairs are carried out by authorized technicians; the electrical installation complies with the appropriate requirements; and the equipment is used in accordance with the instructions for use.



Device contains a Lithium-Polymer battery. Do not damage, crush, burn, freeze or otherwise mishandle the device. Recharge only with the approved power supply and recharger.



Report any serious incidents with the device to Delsys at 508 545 8200 or support@delsys.com.



Trigno Systems should be stored and operated between 5 and 45 degrees Celsius due to the presence of an internal Lithium Polymer rechargeable cell. Storing or operating the device, and consequently the cell, outside of this temperature range may compromise the integrity and the safety features of the cell.

Device Information



Complies with Requirements put forth by the Medical Device Regulation MDR 2017/745. Class I device, Annex VII. Type BF device (IEC 60601-1)



Isolated device, (Class II, IEC 60601-1)



Type BF Equipment.



Date of Manufacturing (appears on device)



Manufacturer:
Delsys Inc.
23 Strathmore Rd.
Natick, MA, 01760, USA



Serial Number (appears on device)



Dispose the device according to local rules for electronic waste.

Authorized Representative:
CS Lifesciences Europe Ltd
The Black Church
St. Mary's Place, Dublin 7
Dublin D07P4AX Ireland



Trigno Wireless Biofeedback System

Sensor Model: SP-W06-019 (“Trigno Avanti Spring Contact Adapter”)

System Model: DS-T03

FCCID: W4P-SP-W06 (Sensor)

FCCID: W4P-SP-W02 (Base Station)

IC: 8138A-DST03 (System)

[R] 211-190332 (DS-T03)

[R] 211-190333 (SP-W06)



This device complies with Part 15 of the FCC Rules and Industry Canada's RSS-210 License Exempt Standards. Operation is subject to the following two conditions: (1) This device may not cause harmful interference. and (2) this device must accept any interference received, including interference that may cause undesired operation.

This Class B digital apparatus complies with Canadian ICES-003.

Cet appareil est conforme à des règlements d'Industrie Canada exempts de licence standard RSS (s). Son fonctionnement est soumis aux deux conditions suivantes: (1) Ce dispositif ne doit pas causer d'interférences nuisibles, et (2) cet appareil doit accepter toute interférence reçue, y compris les interférences pouvant entraîner un fonctionnement indésirable.

Cet appareil numéroté de la classe B est conforme à la norme NMB-003 du Canada

This product complies with FCC OET Bulletin 65 radiation exposure limits set forth for an uncontrolled environment.

To reduce potential radio interference to other users, the antenna type and its gain should be so chosen that the equivalent isotropically radiated power (EIRP) is not more than that required for successful communication.

This equipment has been tested and found to comply with the limits for a Class B digital device, pursuant to Part 15 of the FCC Rules. These limits are designed to provide reasonable protection against harmful interference in a residential installation. This equipment generates, uses, and can radiate radio frequency energy and, if not installed and used in accordance with the instructions, may cause harmful interference to radio communications. There is no guarantee that interference will not occur in a particular installation. If this equipment does cause harmful interference to radio or television reception, which can be determined by turning the equipment off and on, the user is encouraged to try to correct the interference by one or more of the following measures: Reorient or relocate the receiving antenna; increase the separation between the equipment and receiver; Connect the equipment into outlet on a separate circuit.



Pursuant to FCC 15.21 of the FCC rules, changes not expressly approved by Delsys Inc. could void the User's authority to operate the equipment.



Please refer to the main Trigno System User Guide for additional information.

Windows PC Requirements

- Windows 7, 8.1, 10
- One USB 2.0 port
- At least 2.0 GHz processor clock speed
- At least 2 GB system memory
- 1280x1024 (SXGA) display resolution or better
- 50 GB hard disk storage (minimum)

Android Device Requirements

- Android V 7 (Nougat) operating system or later
- BLE 4.2 support
- RAM 1GB minimum
- Storage 8 GB minimum
- Screen Resolution 2048x1536 (recommended)

Trigno System Overview

The Trigno® Avanti Spring Contact Adapter is a biofeedback component of the Trigno Wireless Biofeedback System, a device designed to make EMG (electromyographic) and biofeedback signal detection reliable and easy. The system transmits signals from the Trigno sensors to a receiving base station using a time-synchronized wireless protocol which minimizes data latency across sensors. The core architecture of the Trigno System is designed to support high fidelity EMG signals, along with complementary biofeedback signals such as movement data, force signals, contact pressure events, and timing and triggering information. For mobile biofeedback applications, Trigno Sensors can communicate with Bluetooth BLE 4.2 compliant host devices. The system is also capable of integrating with 3rd party lab equipment through a variety of interfaces which include analog signal generation, triggering scenarios, and digital integration through the Trigno SDK (Software Development Kit) and the Trigno API (Application Program Interface). **Refer to the Trigno System User Guide for System information and operational details.**

Trigno Avanti Spring Contact Adapter Features

The Avanti Spring Contact Adapter is designed for researchers interested in performing EMG signal biofeedback with electrodes terminating in fine wires. The four silver contacts on the main sensor body act as a reference, while the two spring contacts on the head perform the differential EMG signal detection. Each sensor is equipped with the following capabilities and design features:

- Configurable bandwidth 20-450 Hz or 10 - 2000Hz
- built-in 9-axis inertial measurement unit (IMU)
- onboard RMS and Mean calculations
- onboard orientation calculation
- software selectable operational modes
- inter-sensor latency < 1 sample period
- wireless transmission range 20+m¹
- self-contained rechargeable battery
- battery charge monitoring and status indicator
- environmentally sealed enclosure
- low power mode
- auto shutoff
- internal magnetic switch
- LED User Feedback
- Compatible wire diameters of < 28 AWG



1. Communication distance is dependent on the RF operating environment.

Differential EMG Sensing

Trigno sensors feature a low noise, high fidelity sensing strategy for detecting EMG (electromyographic) biofeedback signals when muscles contract. The sensor bandwidth can be selected between 10-2000Hz or 20-450 Hz and the input range of the sensor can be selected between 22mV or 11mV depending on user needs.

Inertial Measurement Unit

Trigno sensors have a built-in 9 DOF inertial measurement unit which can relay acceleration, rotation, and earth magnetic field (compass) information. Users can use this information to discern movement activity time-synchronized with the EMG signals. One of four ranges can be selected for each sensor to span $\pm 2g$ to $\pm 16g$ for accelerometer outputs and $\pm 250^\circ/s$ to $\pm 2000^\circ/s$ for gyroscope outputs. The sensor is capable of estimating orientation in 3D space from the 9 channels of information.

Dual Mode “BLE-Base” Communication

Trigno sensors are capable of communication with a PC-connected Base station using the Trigno custom wireless communication protocol, or with Android devices using the Bluetooth Low Energy (BLE) industry standard protocol. Note that the information bandwidth when operating over Bluetooth is limited by the Bluetooth protocol and the host device capabilities.

Wireless Communication

The Trigno wireless communication scheme offers robust data transmission for up to 16 Trigno sensors operating in full bandwidth mode, with a nominal distance of 20m. Under optimal environmental conditions (no RF path obstructions or interfering sources), this nominal distance can be notably superseded.

Data Synchronization

Data from each sensor and from each channel within a sensor are time synchronized over the Trigno wireless communication protocol so no time skew between data exists. A maximum of 16 sensors can stream data to a host base station at one time. These features are available only when communicating with the PC-connected Base Station; the Bluetooth/BLE protocol does not guarantee latency.

Rechargeable Battery

Sensors contain a sealed rechargeable lithium polymer battery for continuous use which can be extended when making use of low power modes. Actual duration will depend on usage conditions, which are expected to vary between 4 to 8 hours of performance. Charge status is conveniently reported through the wireless communication protocol.

Sealed Enclosure

The environmentally sealed enclosure protects the electronics from the ingress of liquids and other environmental elements and provides a high standard of user safety and durability.

Internal Magnetic Switch

The Trigno sensors are equipped with an internal magnetic switch which is used to turn the sensors “on” and to perform RF pairing operations. To activate the internal magnetic switch, the sensor must be placed on the magnet lock label located on the Base Station charging cradle. The internal magnetic switch will only react when the sensors are undocked from the charger or when the software is performing an RF pairing operation. Exposure to any magnetic fields outside of these 2 qualifying conditions will be ignored by the sensor. The internal magnetic switch is a feature which removes the need for a mechanical button and improves sensor durability and performance. Common household magnets can be used to perform these functions as well.

Sensor LED Feedback States

Trigno Avanti sensors indicate their status through various LED Arrow colors and blink patterns as indicated in the table below. Each of these states is described in subsequent sections of this User Guide.

















	State	Color	Pattern	Arrow Display
Common States				
1	Power Off	Off	none	
2	Power On/Activate	White/Green	fade	
3	Charging	Amber	solid	
4	Charge Complete	Green	solid	
5	Identification Mode	White	rapid flash	
6	Scan (Startup)	Amber/Cyan	slow flash	
7	Power Up Error	Red	slow flash	
Trigno RF Mode				
8	Scan (Base)	Amber/Green	Slow flash	
9	Low Power Scan (Base)	Amber	Occasional Flash	
10	Data Collection (Base)	Green	slow flash	
11	Configuration Change (Base)	Green	rapid flash (3x)	
12	Pairing (Base)	Amber	solid	
13	Pairing Success (Base)	Green	rapid flash (≥6x)	
14	Pairing Fail (Base)	Red	double flash(≥3x)	
BLE Mode				
15	Advertise (BLE)	Cyan	Slow flash	
16	Low Power Advertise (BLE)	Cyan	occasional flash	
17	Data Collection (BLE)	Blue	slow flash	
18	Idle (BLE)	Magenta	slow flash	

Table 1: Sensor LED functions.

LED State Descriptions

- 1) **Power Off:** No LED arrow activity is present when the sensor is off.
- 2) **Power On:** When undocked, the sensor illuminates white and fades to black. A magnetic field will turn the sensor on within 6 seconds, otherwise the arrow fades to dark and sensor turns off.
- 3) **Charging:** Sensor Charging in the Trigno Base Station is denoted by continuous amber LED arrow illumination
- 4) **Charge Complete:** Once the internal sensor battery has been fully recharged, the LED arrow illuminates to continuous green.
- 5) **Identification Mode:** The arrows blink white upon this software command so that it can be easily identified and located.
- 6) **Startup Scan:** upon power-up the sensor actively searches for a host to connect to (PC Base Station or BLE tablet).
- 7) **Power Up Error:** Sensor fails self-check on power up
- 8) **Scan (Base):** Sensor was previously paired and is scanning for the active base station.
- 9) **Low Power Scan (Base):** Sensor was previously paired and has been scanning for the active base station for more than 5 minutes.
- 10) **Data Collection (Base):** Data from sensor are streaming to a paired PC-connected base station.
- 11) **Configuration Change (Base):** Sensor acknowledges change in configuration sensor from host base station.
- 12) **Pairing (Base):** Sensor is performing a pair operation with the base host.
- 13) **Pairing Success (Base):** Sensor successfully completes a pair operation with the Base Station host.
- 14) **Pairing Fail (Base):** The pair operation did not complete successfully with the Base Station host.
- 15) **Advertise (BLE):** Sensor is broadcasting to connect with a BLE host.
- 16) **Low Power Advertise (BLE):** Sensor is broadcasting to connect with a BLE host for more than 5 minutes.
- 17) **Data Collection (BLE):** Sensor is sampling and streaming data to BLE host.
- 18) **Idle (BLE):** Sensor is waiting for a Bluetooth BLE command.

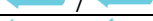
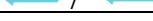
Getting Started with the Trigno Sensor



Please refer to the Trigno System User's Guide for key operational details regarding the base station, sensor charging, and initiating the sensor.

Configuring the Spring Contact Adapter

Once paired to the system, EMG data and IMU data from the sensor can be configured through the software in the following ways:

Electromyographic (EMG) Sensing Ranges							
Input Range ¹	11 mV	or	22 mV				
Bandwidth ¹	20-450 Hz	or	10-2000 Hz				
RMS Window (optional) ⁴	100ms						
Inertial Measurement Unit (IMU) Ranges							
Accelerometer ²	±2 g	or	±4 g	or	±8 g	or	±16 g
Accelerometer Bandwidth ²	24Hz - 470 Hz						
Gyroscope ²	±250 dps	or	±500 dps	or	±1000 dps	or	±2000 dps
Gyroscope Bandwidth ²	24 Hz - 360 Hz						
Orientation ³	10 Hz						

¹EMG range, bandwidth selection and sampling rate are configured by the software. Please refer to the specifications section for additional details.

²Accelerometer and gyroscope range, bandwidth and sampling rate are configured by the software. Please refer to specifications section for additional details

³Note that the orientation is calculated on-board with a data fusion algorithm.

⁴An onboard RMS calculation can be invoked to reduce data transmission rates and maximize bandwidth resources.

Using the Analog Outputs (if Equipped)

The Trigno System provides simultaneous analog signal reconstruction of data being detected by all active sensors. These signals are made available on the 68-pin connectors located on the Base Station and covers the +/-5V range. Analog outputs are engaged through software and are only available for specific sensor sampling configurations as stated below:

	Sampling Rate	Data Type	Bandwidth
Ch. x.1	1926 sa/sec	EMG	20-450 Hz
Ch. x.2	148 sa/sec	ACC or Gyro X	DC-50 Hz
Ch. x.3	148 sa/sec	ACC or Gyro Y	DC-50 Hz
Ch. x.4	148 sa/sec	ACC or Gyro Z	DC-50 Hz

Table 2: Analog Output signal details. Note that sampling rates are approximate; please refer to specification table for precise sampling periods.

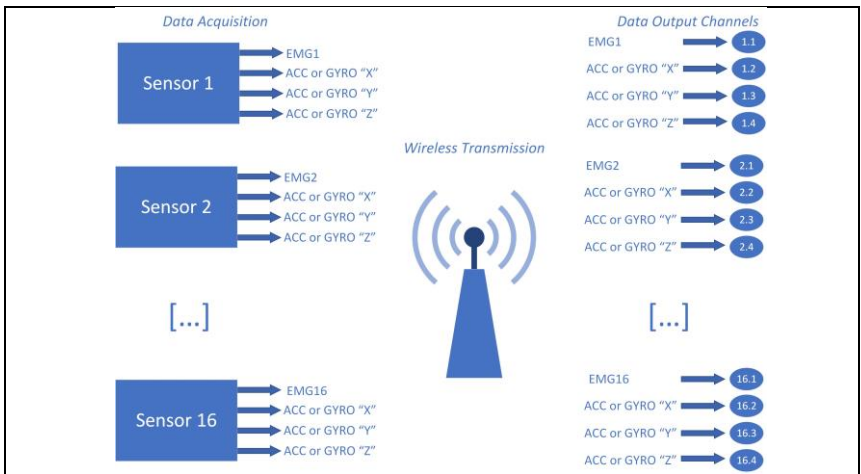

Figure 1: Analog Output Data Flowchart

****Refer to the Trigno System User's Guide for more information on Analog Output Operation.****

Placing the Spring Contact Adapter on the Skin

Trigno Avanti Spring Contact Adapters consist of a main sensor body and a cabled head hosting the spring contacts. The sensor head and body are easily attached to the skin using the Delsys Adhesive Sensor Interfaces. Prior to affixing the Trigno sensor on the surface of the skin, the sensor site for the reference contacts must be properly cleaned to remove dry dermis and any skin oils. Wiping the skin prior to sensor application helps ensure a high-quality signal. If excessive hair is present, it will also be necessary to shave the site. In cases where the skin is excessively dry, it may be useful to dislodge dry skin cells by dabbing the site with medical tape. The dry cells will attach the tape's adhesive when it is removed. Be sure to wipe with isopropyl alcohol to remove any adhesive residue that may remain.

Using the Spring Contacts

Spring contacts are commonly used in biofeedback practice to clamp fine wire electrode terminations. The spring contacts are deflected to create an opening between the coils, and then released to pinch the inserted wire. Wire diameters thinner than 28 AWG are recommended.

Delsys does not manufacture or sell fine wire electrodes.

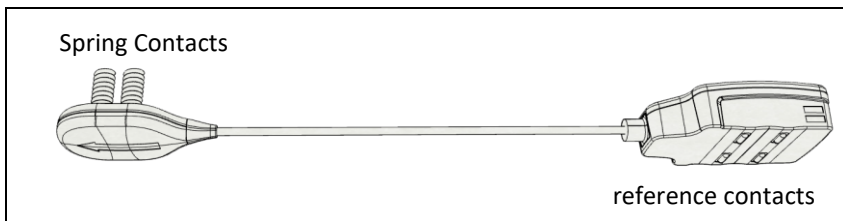

Figure 6. Spring Contact Adapter featuring a detection head and reference contacts.

Applying the Trigno Adhesive Skin Interfaces

The Trigno System is supplied with specially designed adhesive interfaces to simplify sensor attachment. These hypoallergenic interfaces are manufactured from medical grade adhesive approved for dermatological applications. Usage of the interface promotes a high-quality electrical connection between the sensor bars and the skin, minimizing motion artifacts and the ill-effects of line interference. To ensure a strong bond with the skin, it is advised to remove excessive hair and wipe the skin area and the EMG Sensor with isopropyl alcohol to remove oils and surface residue. Allow the skin to dry completely before applying the interfaces.



Adhesive Sensor Interfaces are for single use only. Discard after using. Reseal storage bag to maintain freshness.



Immediately discontinue use if skin irritation or discomfort occurs. Patients with sensitive skin may experience temporary redness and irritation.



Do not use on Patients with allergies to silver.



Do not apply over open wounds or irritated skin.

Maintenance and Care

Trigno Sensors

Trigno sensors are encased in a sealed polycarbonate enclosure. The following points should be kept in mind when handling the sensors.

- All sensors should be visually inspected before each use to ensure that no mechanical deterioration has occurred.
- The sensors can be cleaned with isopropyl alcohol swabs. Ensure that the sensor contacts remain clean at all times for proper operation.
- While the sensors are sealed and are water-resistant, they should never be completely submerged in any liquid.
- The sensor contacts are made of pure silver and are quite soft. Care should be taken to preserve the integrity of these contacts. Do not scrape or dent these contacts.
- Sensor leads are delicate and should be handled gently. Do not pull, kink or twist leads as damage may occur.



Handle the sensors with care: do not drop them on the ground or step on them.



Do not submerge the sensors in any liquid under any circumstance.



Do not pull the cable as this will result in damage.



The sensors contain sensitive electronic circuitry. Static discharges and intense electro-magnetic fields should be avoided to prevent the risk of irreparable damage to the sensors.

Specifications

Physical Specifications

Dimension (Body)	27 x 46 x 13 mm
Dimension (Head)	23 x 30 x 7 mm
Cable Length	254mm (10 inch)
Mass	20g
Temperature Range ⁽¹⁾	5 - 45 degrees Celsius
EMG Contact Dimensions	5 x 1 mm
Contact Material ⁽²⁾	99.99% silver



1) Exposure beyond these temperature limits may damage the rechargeable battery.

2) Sensor skin contacts are made from pure silver and should not be used if allergic reactions to silver are expected or found to occur.

Electrical Specifications

RF Frequency Band	2400-2483 MHz (ISM band)
EMG Signal Input Range	11mV / 22mV r.t.i.
EMG Signal Bandwidth	20-450 Hz / 10-2000 Hz
Accelerometer Range	±2g, ±4g, ±8g, ±16g
Accelerometer Bandwidth	24 Hz – 111Hz (configurable in software)
Gyroscope Range	±250 dps, ±500 dps. ±1000dps, ±2000dps
Gyroscope Bandwidth	24Hz – 360 Hz (configurable in software)
Magnetometer Range	±4900 uT
Magnetometer Bandwidth	50 Hz
Inter-Sensor Delay	< 1 sample period (Base Station only)
Intra-Channel Delay	< 1-2 sample period

EMG Measurement Data Modes



























		Configuration ID	# Data Slots ¹	EMG Sampling Period ² (ms)	EMG Sampling Rate ² (sa/sec)	RMS Window ³ (ms)	RMS Sampling Period ² (ms)	RMS Update Rate ⁴ (sa/sec)	EMG Bandwidth ⁵ (Hz)	EMG Input Range ⁶ (mV)	EMG Resolution Depth ⁷ (bits)	ACC Sampling Period ² (ms)	ACC Sampling Rate ² (sa/sec)	ACC Bandwidth ⁸ (Hz)	ACC Range ⁹ (g)	ACC Resolution ⁷ (bits)	Gyro Sampling Period ² (ms)	GYRO Sampling Rate ² (sa/sec)	GYRO Bandwidth ⁸ (Hz)	Gyro Range ¹⁰ (dps)	Gyro Resolution ⁷ (bits)	
	1	1	1	0.465	2148	--	--	--	20-450	11 22	16	--	--	--	--	--	--	--	--	--	--	--
	2	2	2	0.23	4370	--	--	--	20-450 10-2000	11 22	16	--	--	--	--	--	--	--	--	--	--	--

- 1) The Trigno System is designed with 16 data slots for wireless transmission. Sensors can occupy up to 4 slots depending on the sampling rate settings.
- 2) Sampling period is the precise time elapse between samples in milliseconds. The sampling rate is a rounded expression of 1/"sampling period" expressed as samples/second (sa/sec).
- 3) Analog EMG Sensor Butterworth filter bandwidth: 2 pole high pass corner, 4 pole low pass corner in Hz.
- 4) EMG signal input range of sensor in millivolts.
- 5) sensor resolution depth across input range.



Denotes raw EMG signal acquisition.

Inertial Measurement Data Modes

	Configuration ID	# Data Slots ¹	EMG Sampling Period ² (ms)	EMG Sampling Rate ² (sa/sec)	RMS Window ³ (ms)	RMS Sampling Period ² (ms)	RMS Update Rate ⁴ (sa/sec)	EMG Bandwidth ⁵ (Hz)	EMG Input Range ⁶ (mV)	EMG Resolution Depth ⁷ (bits)	ACC Sampling Period ² (ms)	ACC Sampling Rate ² (sa/sec)	ACC Bandwidth ⁸ (Hz)	ACC Range ⁹ (g)	ACC Resolution ⁷ (bits)	Gyro Sampling Period ² (ms)	GYRO Sampling Rate ² (sa/sec)	GYRO Bandwidth ⁸ (Hz)	Gyro Range ¹⁰ (dps)	Gyro Resolution ⁷ (bits)
  	3	1	0.5	2000	100	6.75	148	20-450	11 22	16	3.375	296	111	±2 ±4 ±8 ±16	16	3.375	296	111	±250 ±500 ±1000 ±2000	16
  	4	1	0.8	1259	--	--	--	20-450	11 22	16	6.75	148	50	±2 ±4 ±8 ±16	10	6.75	148	50	±250 ±500 ±1000 ±2000	10
  	5	1	$\frac{27}{52}$	1926	--	--	--	20-450	11 22	16	6.75	148	50	±2 ±4 ±8 ±16	16	--	--	--	--	--
  	6	1	$\frac{27}{52}$	1926	--	--	--	20-450	11 22	16	--	--	--	--	--	6.75	148	50	±250 ±500 ±1000 ±2000	16
  	7	2	$\frac{135}{17}$	1259	--	--	--	20-450	11 22	16	$\frac{27}{14}$	519	197	±2 ±4 ±8 ±16	16	$\frac{27}{14}$	519	246	±250 ±500 ±1000 ±2000	16
  	8	2	$\frac{135}{17}$	1259	--	--	--	20-450	11 22	16	$\frac{27}{26}$	963	473	±2 ±4 ±8 ±16	16	13.5	74	24	±250 ±500 ±1000 ±2000	16
  	9	2	$\frac{135}{17}$	1259	--	--	--	20-450	11 22	16	3.375	296	111	±2 ±4 ±8 ±16	16	1.35	741	361	±250 ±500 ±1000 ±2000	16
  	10	2	.25	4000	--	--	--	20-450 10-2000	11 22	16	13.5	74	24	±2 ±4 ±8 ±16	16	13.5	74	24	±250 ±500 ±1000 ±2000	16
 	11	1	--	--	--	--	--	--	--	--	2.7	370	111	±2 ±4 ±8 ±16	16	2.7	370	152	±250 ±500 ±1000 ±2000	16

- 1) The Trigno System is designed with 16 data slots for wireless transmission. Sensors can occupy up to 4 slots depending on the sampling rate settings.
- 2) Sampling period is the precise time elapse between samples in milliseconds. The sampling rate is a rounded expression of 1/"sampling period" expressed as samples/second (sa/sec).
- 3) RMS window is the period of raw signal that is captured and process to produce singular RMS value.
- 4) RMS update rate is the rate at which the RMS calculation is updated, expressed as samples/sec (sa/sec).
- 5) Analog EMG Sensor Butterworth filter bandwidth: 2 pole high pass corner, 4 pole low pass corner in Hz.
- 6) EMG signal input range of sensor in millivolts.
- 7) sensor resolution depth across input range.
- 8) IMU bandwidth determined by onboard digital low pass filter
- 9) Accelerometer signal input range in "g" (i.e. 9.8 m/s²)
- 10) Gyroscope angular rate input range in degrees per second (dps).



Denotes raw EMG signal acquisition.



Denotes onboard RMS calculation of the EMG signal.



Denotes onboard 3 DOF accelerometer data.













Denotes onboard 3 DOF gyroscope data.



Denotes analog output supported mode.

Orientation Measurement Data Modes

	Configuration ID	# Data Slots ¹	EMG Sampling Period ² (ms)	EMG Sampling Rate ² (sa/sec)	EMG Bandwidth ³ (Hz)	EMG Input Range ⁴ (mV)	EMG Resolution Depth ⁵ (bits)	Orientation Sampling Period ² (ms)	Orientation Sampling Rate ² (sa/sec)	Orientation Resolution ⁶ (bits)
 	12	1	0.675	1481	20-450	11 22	16	13.5	74	32
 	13	1	0.5625	1778	20-450	11 22	16	13.5	74	16
 	14	2	0.42	2370	20-450	11 22	16	4.5	222	32
 	15	2	0.27	3704	20-450	11 22	16	13.5	74	32
 	16	2	0.25	4000	20-450 10-2000	11 22	16	13.5	74	16

- 1) The Trigno System is designed with 16 data slots for wireless transmission. Sensors can occupy up to 4 slots depending on the sampling rate settings.
- 2) Sampling period is the precise time elapse between samples in milliseconds. The sampling rate is a rounded expression of 1/"sampling period" expressed as samples/second (sa/sec).
- 3) Analog EMG Sensor Butterworth filter bandwidth: 2 pole high pass corner, 4 pole low pass corner in Hz.
- 4) EMG signal input range of sensor in millivolts.
- 5) sensor resolution depth across input range.
- 6) Orientation vector output resolution in bits. Orientation is expressed in quaternions and is performed on the sensor.



Denotes raw EMG signal acquisition.



Denotes onboard calculation of orientation fused from 3 DOF accelerometer, 3 DOF gyroscope and 3 DOF magnetometer data.